



**MAGAZINE
STUDIO
LABORATORIO**



FRIENDS OF SHOFU

GENNAIO - GIUGNO

2026

BeautiLink SA

Nuovo



www.shofu.it



- Cemento resinoso universale, a polimerizzazione duale, autoadesivo con viscosità ideale per un semplice utilizzo
- Eccellente legame adesivo allo smalto, dentina e tutte le ceramiche, compreso l'ossido di zirconio, metallo e composito
- Applicazione semplificata, non è necessario l'utilizzo del primer
- Rilascio di fluoro grazie alla tecnologia Giomer
- Colorazione opaca con elevata capacità di mascheramento
- Conservazione a temperatura ambiente (1-25 °C)

La soluzione universale!

BeutiLink SA

Cemento resinoso universale duale - self adhesive



NUOVO

PER MAGGIORI
INFORMAZIONI



Pagina 64



Clear (Trasparente)



0,3 mm 0,5 mm 1,0 mm

Ivory (Aavorio)



0,3 mm 0,5 mm 1,0 mm

Opaque (Opaco)



0,3 mm 0,5 mm 1,0 mm

- ECCELLENTE ADESIONE ALLA CERAMICA INTEGRALE COMPRESO OSSIDO DI ZIRCONIO, METALLO E COMPOSITO
- COLORAZIONE OPACA CON ELEVATA CAPACITÀ DI MASCHERAMENTO
- NON È NECESSARIO L'UTILIZZO DEL PRIMER
- APPLICAZIONE SEMPLICE E VELOCE
- SPESSORE MINIMO (14 μ m)
- ELEVATA RADIOPACITÀ (1,9 MM/Al)

REF	Q.tà	Prodotto
CE0203	1pz	BeutiLink SA siringa, 5 ml "Clear" miscelazione automatica, incl. 10 cannule di miscelazione.
CE0204	1pz	BeutiLink SA siringa, 5 ml "Ivory" miscelazione automatica, incl. 10 cannule di miscelazione.
CE0205	1pz	BeutiLink SA siringa, 5 ml "Opaque" miscelazione automatica, incl. 10 cannule di miscelazione.
CE0215	2pz	BeutiLink SA siringa, 5 ml "Clear" miscelazione automatica, incl. 20 cannule di miscelazione.
CE0216	2pz	BeutiLink SA siringa, 5 ml "Ivory" miscelazione automatica, incl. 20 cannule di miscelazione.
CE0217	2pz	BeutiLink SA siringa, 5 ml "Opaque" miscelazione automatica, incl. 20 cannule di miscelazione.

Conf. 1 SIRINGA

€ 95,00

(IVA ESCLUSA)

Conf. 2 SIRINGHE

€ 169,00

(IVA ESCLUSA)



BeutiBond Xtreme

ADESIVO UNIVERSALE

PER MAGGIORI
INFORMAZIONI



Pagina 58

4



€ 65,00

(BeutiBond Xtreme flacone)

€ 85,50

(BeutiBond Xtreme Set)

€ 162,00

(BeutiBond Xtreme Value Pack)

(3 flaconi x 5ml)

(IVA ESCLUSA)

- FACILE UTILIZZO
- FORTE ADESIONE
- NUOVO SILANO ARS
(Acid-Resistant Silane coupling agent)
- NON NECESSITA DI PRIMER AGGIUNTIVO.

REF	Q.tà	Prodotto
YE2447	1pz	BeutiBond Xtreme Value Pack
YE2448	1pz	BeutiBond Xtreme Set
YE2449	1 pz.	BeutiBond Xtreme, flacone, 5 ml

BEAUTIFIL II LS

COMPOSITO IN PASTA



PER MAGGIORI
INFORMAZIONI



Pagina 52

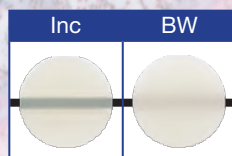
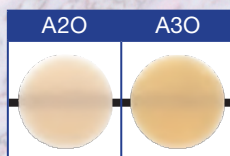

Colore	REF 4 g
SIRINGHE	
A1	YE2270
A2	YE2271
A3	YE2272
A3,5	YE2273
A4	YE2274
B1	YE2275
B2	YE2276
B3	YE2277
C2	YE2278
C3	YE2279
A20 (opaco A2)	YE2280
A30 (opaco A3)	YE2281
Inc (Incisal)	YE2282
BW (Bleaching White)	YE2283

Colore	REF 0,25 g
TIPS, 20 PZ.	
A1	YE2284
A2	YE2285
A3	YE2286
A3,5	YE2287
A4	YE2288
B1	YE2289
B2	YE2290
B3	YE2291
C2	YE2292
C3	YE2293
A20 (opaco A2)	YE2294
A30 (opaco A3)	YE2295
Inc (Incisal)	YE2296
BW (Bleaching White)	YE2297

- MINIMA CONTRAZIONE
- RILASCIO DI FLUORO
- ECCELLENTE LUCIDABILITÀ E LUCENTEZZA DURATURA
- MASSIMA ESTETICA

2 SIRINGHE
a scelta

TOT € 87,00

(IVA ESCLUSA)



BEAUTIFIL Flow Plus X

COMPOSITO FLOW

PER MAGGIORI INFORMAZIONI



Pagina 46

Colore	REF 2,2 g
SIRINGA F03	
A1	YE2321N
A2	YE2322N
A3	YE2323N
A3,5	YE2324N
A4	YE2325N
B1	YE2326N
B2	YE2327N
C2	YE2328N
D2	YE2329N
SA0,5	YE2320N
A2O (opaco A2)	YE2332N
A3O (opaco A3)	YE2333N
Inc (Incisal)	YE2334N
BW (Bleaching White)	YE2335N
MI (Milky)	YE2336N
CV (Cervical)	YE2337N



Colore	REF 2,2 g
SIRINGA F00	
A1	YE2301N
A2	YE2302N
A3	YE2303N
A3,5	YE2304N
A4	YE2305N
B1	YE2306N
B2	YE2307N
C2	YE2308N
D2	YE2309N
SA0,5	YE2300N
SA0,5O (opaco A0,5)	YE2310N
A1O (opaco A1)	YE2311N
A2O (opaco A2)	YE2312N
Inc (Incisal)	YE2314N
BW (Bleaching White)	YE2315N



PER MAGGIORI INFORMAZIONI



Pagina 46

BEAUTIFIL Flow Plus X F00 GINGIVA

MASSE GENGIVALI IN COMPOSITO FLOW

NUOVO

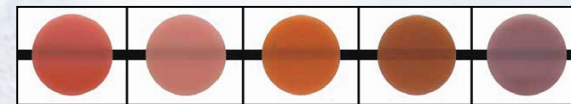

Dark Pink Light Pink Orange Brown Violet



Colore	REF 2,2 g
SIRINGA F00 GINGIVA	
G-Br (G-Brown)	YE2340
B-DP (G-Dark Pink)	YE2341
G-LP (G-Light Pink)	YE2342
G-Or (G-Orange)	YE2343
G-V (G-Violet)	YE2344

6

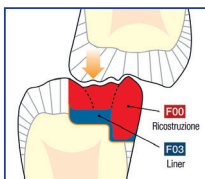

3 SIRINGHE
a scelta

€ 78,00

(IVA ESCLUSA)

- UTILIZZO UNIVERSALE
- ELEVATA LUCIDABILITÀ
- ESTETICA NATURALE
- RILASCIO DI FLUORO

1 SIRINGA a scelta

€ 33,55

(IVA ESCLUSA)

2 SIRINGHE a scelta

TOT € 62,00

(IVA ESCLUSA)

QUESTA NUOVA LINEA UNISCE LE CARATTERISTICHE E LE PROPRIETÀ DEL COMPOSITO FLOW F00, INCLUSA LA FACILITÀ DI LAVORAZIONE, CON I 5 COLORI DEI COMPOSITI BEAUTIFIL II GINGIVA E PERMETTE LA REALIZZAZIONE DI RESTAURI ESTETICI IN PRESENZA DI RESSIONI GENGIVALI E CAVITÀ DI V CLASSE

BEAUTIFIL II Gingiva & Enamel

MASSE ESTETICHE GENGIVALI / MASSE EFFETTI SMALTO



Colori

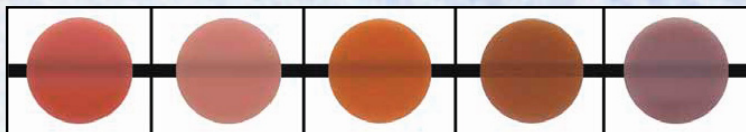

Dark Pink Light Pink Orange Brown Violet



Colore	REF 2,5 g
GINGIVA	
Gum-LP (Light Pink)	YE2256
Gum-DP (Dark Pink)	YE2257
Gum-V (Violet)	YE2258
Gum-Br (Brown)	YE2259
Gum-Or (Orange)	YE2260

Colori

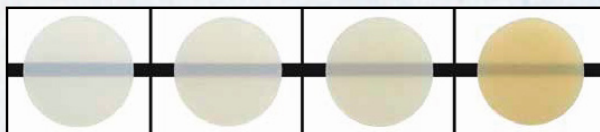

High Value Translucent Translucent Low Value Translucent Amber



Colore	REF 2,5 g
ENAMEL	
T (Translucent)	YE2250
HVT (High-Value Tr.)	YE2251
LVT (Low-Value Tr.)	YE2252
AM (Amber)	YE2253

PER MAGGIORI
INFORMAZIONI



Pagina 54

- ESTETICA BIANCA E ROSA
- FACILE CORRISPONDENZA CROMATICA
- RILASCIO DI FLUORO

1 SIRINGA
a scelta
€ 49,50

(IVA ESCLUSA)



BEAUTIFIL Bulk Flowable

COMPOSITO BULK FLUIDO

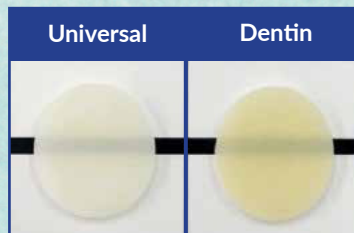

REF	Prodotto
YE2028	BEAUTIFIL-Bulk Flowable 0.23g Universal Tips 20pcs
YE2029	BEAUTIFIL-Bulk Flowable 0.23g Dentin Tips 20pcs
YE2030	BEAUTIFIL-Bulk Flowable 2.4g Universal Syringe 1pc
YE2031	BEAUTIFIL-Bulk Flowable 2.4g Dentin Syringe 1pc

PER MAGGIORI INFORMAZIONI



Pagina 55

BEAUTIFIL Bulk Restorative

COMPOSITO BULK IN PASTA

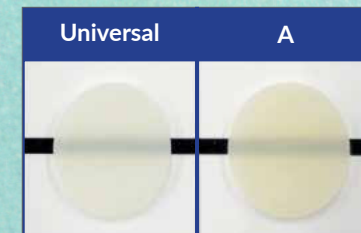

REF	Prodotto
YE2032	BEAUTIFIL-Bulk Restorative 0.25g Universal Tips 20
YE2033	BEAUTIFIL-Bulk Restorative 0.25g A Tips 20pcs
YE2034	BEAUTIFIL-Bulk Restorative 4.5g Universal Syringe
YE2035	BEAUTIFIL-Bulk Restorative 4.5g A Syringe 1pc

BEAUTIFIL BULK FLOWABLE

1 SIRINGA a scelta

€ 37,65

(IVA ESCLUSA)

- DUE VISCOSITÀ: FLUIDA E MODELLABILE
- RIDOTTA CONTRAZIONE DA POLIMERIZZAZIONE
- ECCELLENTE PROFONDITÀ DI POLIMERIZZAZIONE PER INCREMENTI DI SPESSORE FINO A 4 MM
- RILASCIO DI FLUORO
- OTTIMALE ADATTAMENTO CROMATICO (EFFETTO CAMALEONTICO)
- ELEVATA RADIOPACITÀ
- FACILMENTE LUCIDABILE

BEAUTIFIL BULK RESTORATIVE

1 SIRINGA a scelta

€ 60,00

(IVA ESCLUSA)

EyeSpecial C-V

FOTOCAMERA PER USO DENTALE



Gestione veloce ed intuitiva del menu

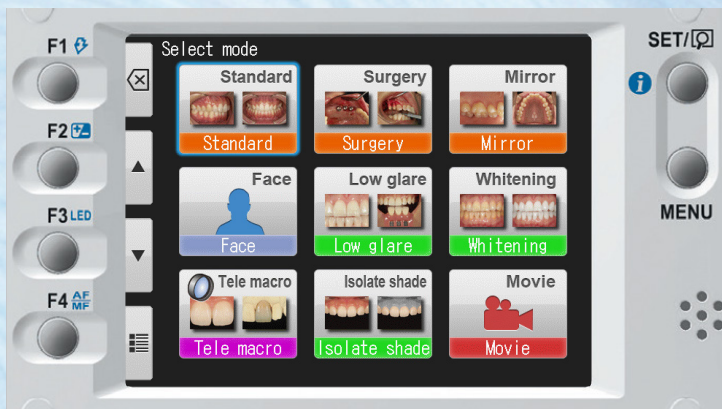

- DISPLAY AD ALTO CONTRASTO CON FUNZIONE TOUCH
- NOVE MODALITÀ DI SCATTO PREIMPOSTATE PER UN UTILIZZO SEMPLICE ED AFFIDABILE
- FUNZIONE FILMATO CON AUTOFOCUS PERMANENTE
- FUNZIONE WI-FI PER IL TRASFERIMENTO DELLE IMMAGINI
- CONTROLLO AUTOMATICO DEL FLASH PER UN'OTTIMALE ILLUMINAZIONE
- FILTRO POLARIZZATORE OPZIONALE



EyeSpecial C-V
-
Valigetta
**Prezzo
a richiesta**

PER MAGGIORI
INFORMAZIONI



Pagina 114



BeutiCem Veneer

CEMENTO ESTETICO FOTOPOLIMERIZZABILE PER FACCETTE E INTARSI

PER MAGGIORI INFORMAZIONI



Pagina 65



10

REF	Q.TÀ	PRODOTTO
C0002	1 pz	BeutiCem Veneer Kit - Value 3 siringhe Paste (L-Value,M-value,H-Value) 2g cad / 3 siringhe Try-In Paste (L-Value,M-value, H-Value) 1,3ml cad., 50 puntali di ricambio, 50 pennellino MicroBrush Fine, 25 vaschette.

Shade	REF 2 g PASTE
L-Value	C0004
M-Value	C0005
H-Value	C0006
Ivory-L	C0007
Ivory-D	C0008

Shade	REF 1,2 ml TRY-IN PASTE
L-Value	C0009
M-Value	C0010
H-Value	C0011
Ivory-L	C0012
Ivory-D	C0013

SET € 199,00

(IVA ESCLUSA)

1 SIRINGA PASTE A SCELTA

€ 42,00

(IVA ESCLUSA)

1 SIRINGA TRY-IN PASTE A SCELTA

€ 24,75

(IVA ESCLUSA)

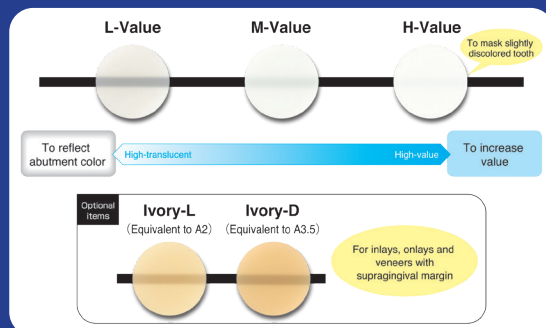

- FACILI DA UTILIZZARE
- PASTE PROVA TRY-IN PER SIMULAZIONE CROMATICA DELLA CEMENTAZIONE
- RILASCIO DI FLUORO

Glaslonomer Cement CX - PLUS

CEMENTO DI FISSAGGIO VETROIONOMERICO

PER MAGGIORI
INFORMAZIONI



Pagina 66

Glaslonomer FX ULTRA

MATERIALE PER OTTURAZIONI VETROIONOMERICO
AUTOPOLIMERIZZANTE, UNIVERSALE

PER MAGGIORI
INFORMAZIONI



Pagina 56



PN	Q.tà	Prodotto
1166	1 pz	CX-Plus Set polvere 35 g. liquido 17 ml



Cod.	Prodotto
1125	Glaslonomer FX Ultra col. A2 polvere 15 gr. Liquido 8 ml.
1126	Glaslonomer FX Ultra col. A3 polvere 15 gr. Liquido 8 ml.
1127	Glaslonomer FX Ultra col. A3,5 polvere 15 gr. Liquido 8 ml.
1128	Glaslonomer FX Ultra col. B2 polvere 15 gr. Liquido 8 ml.

- RILASCIO E RICARICA DI FLUORO
- INDICATO PER LA CEMENTAZIONE DI PERNI, CORONE, PONTI ANCHE ESTESI, INLAY E ONLAY
- LUNGO TEMPO DI LAVORAZIONE
- RADIOPACO

GLASIONOMER CX PLUS

€ 67,00

(IVA ESCLUSA)

- OTTURAZIONI DI DENTI DECIDUI
- OTTURAZIONI DI CAVITÀ NON SOLLECITATE DI I E II CLASSE IN PAZIENTI ADULTI
- OTTURAZIONI DI CAVITÀ DI III E V CLASSE COMPRESO EROSIONI CERVICALI, ABRASIONI RADICOLARI E DIFETTI A FORMA DI CUNEO
- RICOSTRUZIONI DI MONCONI

GLASIONOMER FX ULTRA

€ 67,00

(IVA ESCLUSA)



Dura-White

PUNTE ABRASIVE ARKANSAS

PER MAGGIORI INFORMAZIONI



Pagina 13



PER MAGGIORI INFORMAZIONI



Pagina 14



12

1 CONFEZIONE
a scelta

€ 23,00

(IVA ESCLUSA)

3 CONFEZIONI
a scelta

TOT € 60,00

(IVA ESCLUSA)

- AMPIA GAMMA DI FORME
- RIFINITURA CERAMICA - COMPOSITO - SOSTANZA DURA DEL DENTE
- MOVIMENTO DI ROTAZIONE PRECISO
- GAMBO: HP-CA-FG

1 CONFEZIONE
a scelta

€ 21,50

(IVA ESCLUSA)

3 CONFEZIONI
a scelta

TOT € 57,00

(IVA ESCLUSA)

- AMPIA GAMMA DI FORME
- PRE-LUCIDATURA COMPOSITO SOSTANZA DURA DEL DENTE
- SVILUPPO DI CALORE LIMITATO
- GAMBO: CA-FG

OneGloss M

RIFINITURA/LUCIDATURA COMPOSITO MONOPASSAGGIO



REF	Q.TÀ	PRODOTTO
0186-0189	12 pz	OneGloss M, forme montate gambo CA - Cup, Midpoint, IC, Minipoint

PER MAGGIORI INFORMAZIONI



Pagina 22

ZiLMaster Assortment

LUCIDATURA OSSIDO DI ZIRCONIO/DISILICATO DI LITIO



PER MAGGIORI INFORMAZIONI



Pagina 16



PRELUCIDATURA GAMBO VERDE

LUCIDATURA A SPECCHIO
GAMBO GIALLO

LUCIDATURA GAMBO BLUE

REF	Q.TÀ	PRODOTTO
OneGloss M		
0664	1 conf.	ZiLMaster Coarse, gambo CA, 1 ogiva, lenticolare, coppa, minipoint
0669	1 conf.	ZiLMaster Medium, gambo CA, 1 ogiva, lenticolare, coppa, minipoint
0674	1 conf.	ZiLMaster Fine, gambo CA, 1 ogiva, lenticolare, coppa, minipoint

- UNICO PASSAGGIO
- STERILIZZABILI
- GAMBO: CA

1 CONFEZIONE
a scelta

€ 23,90

(IVA ESCLUSA)

3 CONFEZIONI
a scelta

TOT € 59,90

(IVA ESCLUSA)

- NESSUNA PASTA LUCIDANTE AGGIUNTIVA
- GAMBO: CA

1 CONFEZIONE
a scelta

€ 57,60

(IVA ESCLUSA)



SHOFU BLOCK HC (MONOLAYER/2LAYER)

CERAMICA IBRIDA 190 Mpa

PER MAGGIORI INFORMAZIONI



Pagina 76



• ESTETICA NATURALE

• ATTACCO UNIVERSALE ED ATTACCO CEREC

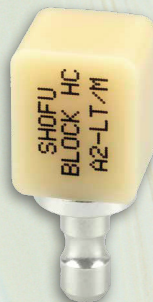
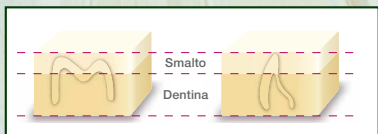

Shofu Block HC (Monolayer)

3+1 € 105,00 CAD.

Shofu Block HC (2Layer)

3+1 € 118,00 CAD.

(IVA ESCLUSA)

SHOFU DISK HC

DISCO DI CERAMICA IBRIDA 190 Mpa

PER MAGGIORI INFORMAZIONI



Pagina 76

• DIAMETRO 98,5 MM X 14 MM



Shofu Disk HC

€ 299,00

(IVA ESCLUSA)

SHOFU BLOCK HC HARD

CERAMICA IBRIDA 270 Mpa

PER MAGGIORI INFORMAZIONI



Pagina 75



- ELEVATA RESISTENZA ALLA FLESSIONE
- ESTETICA NATURALE
- SHOFU BLOCK HC/BLOCK HC HARD MM 12 X 14 X 18
- ATTACCO UNIVERSALE ED ATTACCO CEREC

SHOFU BLOCK HC HARD

3+1 € 107,50 CAD.

(IVA ESCLUSA)

NUOVO

ClearForm X

INJECTION TECHNIQUE

Il silicone trasparente per una semplice tecnica ad iniezione



- Durezza Shore A65 ben bilanciata
- Applicazione semplice e pulita grazie al sistema a cartuccia
- Elevata tissotropia per un'applicazione precisa che esclude uno scorrimento incontrollato del materiale
- Dimensioni stabili e forma inalterata nel tempo
- Versatile nell'uso
- Lavorazione più rapida rispetto al classico sistema con la muffola
- Riproduzione accurata dei dettagli anche nelle strutture più sottili



CERAMAGEUP



BEAUTIFIL Flow Plus X

CLEARFORM X

€ 59,00

(IVA ESCLUSA)

**CONFEZIONE 2 CARTUCCE
X 50 ML + 6 PUNTALI**

L'ossido di zirconio Premium Multipower

Nuovo



www.shofu.it



- Spessori aggiuntivi (25 e 30 mm) per lavori molto voluminosi
- Disponibile in 19 colori, compresi tutti i colori VITA* Classical da A1 a D4
- Resistenza alla flessione fino a 1.454 MPa
- Molteplici indicazioni: fino a ponti di 14 elementi
- Indicato per la tecnica di pittura, cut-back e rivestimento estetico
- Sfumatura armoniosa del colore e della traslucenza

Per la
cementazione
utilizza

BeautiLink SA

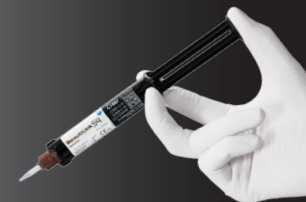

VINTAGE
Art
Universal

Tecnica
di pittura 2D
e 3D per
l'ottimizzazione
estetica



Vuoi far parte
del progetto
**SHOFU
EXCELLENCE
LAB?**



CERAMAGE
meets digital

PER MAGGIORI
INFORMAZIONI
Pagina 72-73



VINTAGE ART UNIVERSAL

SUPERCOLORI PER ZIRCONIO - DISILICATO DI LITIO - CERAMICA



PER MAGGIORI
INFORMAZIONI



Pagina 92



REF	PRODOTTO
P0723	Basic Color Set

- ESTETICA NATURALE
- PER CERAMICHE A BASSO E ALTO PUNTO DI FUSIONE
- COLORI ESPRESSIVI

SET

€ 523,00

CONFEZIONE SINGOLA

1 PEZZO € 29,00

3 PEZZI TOT € 78,00

(IVA ESCLUSA)

REF	Q.TÀ	PRODOTTO
P1695	50 ml	Yamamoto Liquid

- COLORI REALI GIÀ PRIMA DELLA COTTURA
- PITTURA 3D CON EFFETTO NATURALE
- INDICE DI RIFRAZIONE DELLA LUCE SIMILE A QUELLA DEL VETRO

YAMAMOTO
LIQUID

€ 95,00

(IVA ESCLUSA)



VINTAGE PRIME PRESS

VETROCERAMICA AL DISILICATO DI LITIO

- **E (ENAMEL)**
Elevata trasmissione della luce, simile a quella dello smalto
- **HT (HIGH TRANSLUCENCY)**
Traslucenza moderata per corone e ponti
- **LT (LOW TRANSLUCENCY)**
Bassa traslucenza per preparazioni leggermente discromiche
- **HO (HIGH OPACITY)**
Elevata opacità per mascherare abutment e strutture



PER MAGGIORI INFORMAZIONI



Pagina 88

18

- ESTETICA NATURALE
- ELEVATA RESISTENZA ALLA FLESSIONE (FINO A 525 MPA)
- 43 COLORI - 4 TRASLUCENZE
- TECNOLOGIA HDIL HIGH-DENSITY INTERLOCKING

1 CONFEZIONE
a scelta

€ 87,00

(IVA ESCLUSA)

3 CONFEZIONI
a scelta

TOT € 255,00

(IVA ESCLUSA)

VINTAGE LD

DISILICATO DI LITIO - OSSIDO DI ZIRCONIO

- SEMPLICE LAVORAZIONE



Pagina 86

NUOVO

1 CONFEZIONE
a scelta (20 gr)

€ 54,00

(IVA ESCLUSA)

VINTAGE PRO

METALLO CERAMICA

- MASSIMA ESTETICA
- VERSATILI



Pagina 82



1 CONFEZIONE
a scelta (15 gr)

€ 26,00

(IVA ESCLUSA)

VINTAGE ZR

OSSIDO DI ZIRCONIO

- MASSIMA STABILITÀ



Pagina 89



1 CONFEZIONE
a scelta (15 gr)

€ 32,40

(IVA ESCLUSA)



LITE ART FULL SET

SUPERCOLORI FOTOPOLIMERIZZABILI

REF	Q.TÀ	PRODOTTO
1970	1 pz.	Lite Art Full Set



PER MAGGIORI
INFORMAZIONI



Pagina 104



Colore	REF 1 ml
LITE ART	
W (White)	1971
B (Black)	1972
R (Red)	1973
K (Khaki)	1976
O (Orange)	1977
Bl-G (Blue Gray)	1978
V (Violet)	1979
O-Br (Orange Brown)	1980
DR-Br (Dark Red Brown)	1981
B-Br (Black Brown)	1982
Cyan	1983
Magenta	1984
Y (Yellow)	1985
AS (A-Shade)	1974
BS (B-Shade)	1975



CON LITE ART CLEAR
LIQUID SI PUÒ REGOLARE
L'INTENSITÀ DEI COLORI IN
PASTA (INCLUSO NEL KIT)

**LITE ART
CLEAR LIQUID**
Flacone, 6 ml
€ 27,00
(IVA ESCLUSA)

- **APPLICAZIONE SEMPLICE**
- **CARATTERIZZAZIONI
INDIVIDUALI**
- **FLUORESCENZA NATURALE**

LITE ART FULL SET
€ 339,00
(IVA ESCLUSA)

**3 SIRINGHE
a scelta**
TOT € 60,00
(IVA ESCLUSA)



CERAMAGE UP

COMPOSITO MICRO IBRIDO FLUIDO

PER MAGGIORI
INFORMAZIONI



Pagina 102



PER MAGGIORI
INFORMAZIONI



Pagina 100

CERAMAGE

COMPOSITO MICRO IBRIDO PASTA



3 SIRINGHE
a scelta

TOT € 140,00

(IVA ESCLUSA)

- TECNICA INIEZIONE
STAMPAGGIO
STRATIFICAZIONE LIBERA
- ESTETICA E OPALESCENZA
NATURALI

3 SIRINGHE
a scelta

TOT € 126,00

(IVA ESCLUSA)

- ELEVATA RESISTENZA
ALL'ABRASIONE
- INDICAZIONI ILLIMITATE

SHOFU UNIVERSAL Primer

(Metallo-Zirconia)

REF	Q.TÀ
Y0060	5 ml

SHOFU UNIVERSAL PRIMER

€ 137,00

(IVA ESCLUSA)



SHOFU RESIN GLAZE PRIMER

REF	Q.TÀ
Y0003	6 ml

SHOFU RESIN GLAZE PRIMER

€ 47,00

(IVA ESCLUSA)



SHOFU RESIN GLAZE LIQUID

REF	Q.TÀ
Y0004	6 ml

SHOFU RESIN GLAZE LIQUID

€ 35,50

(IVA ESCLUSA)



CRB BOND 1&2

(Adesivo Universale)

CRB
€ 183,50

(IVA ESCLUSA)



REF	Q.TÀ
1741	1 pz.

DURA-POLISH

(Pasta pre-lucidatura)

REF	Q.TÀ
0552	1 pz.

DURA-POLISH

€ 51,00

(IVA ESCLUSA)



DURA-POLISH DIA

(Pasta lucidatura a specchio)

REF	Q.TÀ
0554	1 pz.

DURA-POLISH DIA

€ 82,00

(IVA ESCLUSA)



M-PM DISC MONOLAYER

PMMA AD ALTE PRESTAZIONI



- 16 COLORI V-CLASSIC A1-D4 TRASLUCENTI
- 4 COLORI BLEACH BL1-BL4 TRASLUCENTI

- CLASSE II A
- RESTAURO SEMI-PERMANENTE FINO A 3 ANNI
- ALTA DENSITÀ PER FRESATURE PRECISE
- OTTIMO PER IL CONDIZIONAMENTO DEI TESSUTI MOLLI POST IMPIANTO
- ESTETICO E RIBASABILE

COLORI

DENTALI/TRASPARENTE

H 20 mm x Ø 95 mm € 47,⁰⁰

H 16 mm x Ø 98,5 mm € 39,⁸⁰

H 20 mm x Ø 98,5 mm € 47,⁰⁰

COLORE GENGIVA PINK

H 25 mm x Ø 98,5 mm € 74,⁰⁰

COLORE GENGIVA PINK 3

H 25 mm x Ø 98,5 mm € 67,⁰⁰

(IVA ESCLUSA)

M-PM CRYSTAL

PMMA TERMOELASTICO TRASPARENTE

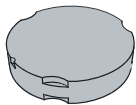
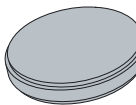

	REF
	Ø 95 mm x 14 mm 1019262
	Ø 95 mm x 16 mm 1019254
	Ø 95 mm x 20 mm 1019255
	Ø 95 mm x 25 mm 1019256
	Ø 95 mm x 30 mm 1019257
	REF
	Ø 98,5 mm x 14 mm 1019263
	Ø 98,5 mm x 16 mm 1019250
	Ø 98,5 mm x 20 mm 1019251
	Ø 98,5 mm x 25 mm 1019252
	Ø 98,5 mm x 30 mm 1019253

- CLASSE II A
- CALCINABILE
- ELEVATA TRASPARENZA
- DIME CHIRURGICHE
- PLACCHE OCCLUSALI

H 14 mm € 31,⁵⁰

H 16 mm € 31,⁵⁰

H 20 mm € 35,⁷⁰

H 25 mm € 38,²⁵

H 30 mm € 40,⁵⁰

(IVA ESCLUSA)



PER MAGGIORI



INFORMAZIONI

PER MAGGIORI



INFORMAZIONI

- RESTAURO SEMI-PERMANENTE FINO A 3 ANNI
- CLASSE II A
- DISPONIBILE IN 16 COLORI VITA E 4 BLEACH
- PONTI SINO A 4 ELEMENTI
- OTTIMO PER IL CONDIZIONAMENTO DEI TESSUTI MOLLI POST IMPIANTO
- RIBASABILE



1 CONFEZIONE
A SCELTA da 2 pz.

€ 39,00

(IVA ESCLUSA)

DIMENSIONI BLOCCHETTI 15.5 X 19 X 39 MM

Colore	Q.tà	A1 REF	A2 REF	A3 REF	A3.5 REF	A4 REF	B1 REF	B2 REF	B3 REF	B4 REF
monocromatico	2 pz.	1017721	1017722	1017723	1017724	1017725	1017726	1017727	1017728	1017729A3,5
monocromatico traslucido	2 pz.	1017721	1017722	1017723	1017724	1017725	1017726	1017727	1017728	1017729A3,5
Colore	Q.tà	C1 REF	C2 REF	C3 REF	C4 REF	D2 REF	D3 REF	D4 REF		
monocromatico	2 pz.	1017730	1017731	1017732	1017733	1017735	1017736	1017737		
monocromatico traslucido	2 pz.	1017679	1017680	1017681	1017682	1017683	1017684	1017685		
Colore	Q.tà	BL1 REF	BL2 REF	BL3 REF	BL4 REF					
monocromatico	2 pz.	1017738	1017739	1017740	1017741					
monocromatico traslucido	2 pz.	1017686	1017687	1017688	1017689					

Promolux

RESINA POLIMERIZZAZIONE A CALDO



PER MAGGIORI



INFORMAZIONI

Weropress

RESINA POLIMERIZZAZIONE A FREDDO



PER MAGGIORI



INFORMAZIONI

PROMOLUX
LIQUIDO (1000 ml)

€ 21,50

(IVA ESCLUSA)

PROMOLUX
POLVERE (1000 gr)

€ 50,00

(IVA ESCLUSA)

- STABILITÀ CROMATICA
- FACILE LUCIDABILITÀ
- NESSUN COLORANTE AL CADMIO
- BIOCOMPATIBILITÀ TESTATA

WEROPRESS
LIQUIDO (1000 ml)

€ 75,00

(IVA ESCLUSA)

WEROPRESS
POLVERE (1000 gr)

€ 85,00

(IVA ESCLUSA)



CERAMAGE
meets digital

Il concetto di rivestimento estetico microibrido

- Spettro di indicazioni quasi illimitato
- Riproduzione facile ed efficiente di tutti i colori della scala VITA* Classical
- Estetica ed opalescenza naturali
- Resistenza e comportamento all'abrasione eccellenti
- Adesione sicura alle diverse leghe dentali e ai materiali per strutture in ceramica e ceramica ibrida con il sistema adesivo CERARESIN BOND e SHOFU Universal Primer
- Lucidabilità e densità superficiale eccellenti



■ CERAMAGE

■ CERAMAGEUP

M-Print Model

LIQUIDO DI STAMPA PER MODELLI



- ELEVATA PRECISIONE
- STABILE DIMENSIONALMENTE
- OTTIMA VISIBILITÀ DEI DETTAGLI

M-PRINT MODEL
1 CONF.

€ 105,00

(IVA ESCLUSA)

colorazioni disponibili
(Sand, Ash Gray e Grey Toupe)

M-Print TryIn

LIQUIDO DI STAMPA PER PROTESI
PROVVISORIE - CLASSE I



- DISPONIBILE NEI COLORI
AVORIO E GENGIVA

- ALTA PRECISIONE
- PRIVO DI TPO

M-PRINT TRYIN

1 CONF. 1Kg. Ivory

€ 175,00

1 CONF. 500g. Ivory

€ 98,00

1 CONF. 1Kg. Gum

€ 190,50

1 CONF. 500g. Gum

€ 108,50

(IVA ESCLUSA)

M-PRINT Model ISO

AGENTE ISOLANTE PER RESINE
STAMPATE IN 3D



- L'AREA DI ISOLAMENTO È MOLTO VISIBILE GRAZIE AL COLORE BLU DEL PRODOTTO
- È SUFFICIENTE UNA SOLA APPLICAZIONE
- PUÒ ESSERE LAVATO VIA SENZA LASCIARE RESIDUI

- ADERISCE E ISOLA ANCHE LA CERA, NESSUN PROBLEMA CON SOTTOSQUADRI BLOCCATI
- ISOLAMENTO RESINE ACRILICHE E MATERIALI COMPOSITI
- APPLICAZIONE UNIFORME

**M-PRINT
MODEL ISO**

€ 38,00

(IVA ESCLUSA)



Veracia

DENTI ANATOMICI IN COMPOSITO



PER MAGGIORI INFORMAZIONI



Pagina 108

26

Veracia SA

DENTI SEMI-ANATOMICI IN COMPOSITO



- MICRO FILLED HYBRID (MF-H) COMPOSITO IBRIDO MICRORIEMPITO
- TESSITURA SUPERFICIALE NATURALE
- INDICATI PER TUTTE LE TECNICHE DI MONTAGGIO
- IDEALI PER QUALSIASI INDICAZIONE PROTESICA

BOCCA
COMPLETA

TOT € 72,00

(IVA ESCLUSA)

BOCCA
COMPLETA

TOT € 72,00

(IVA ESCLUSA)

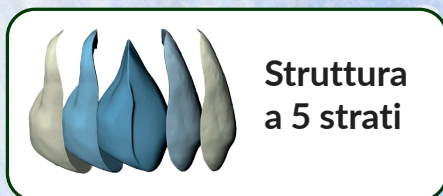

PER MAGGIORI



INFORMAZIONI

- POLIMERI INNOVATIVI
- VASTO ASSORTIMENTO DI FORME
- ELEVATA RESISTENZA ALL' ABRASIONE

OFFERTA
50+15 pz
in omaggio

SHOFU DENTAL ITALY: Via Ugo Foscolo 9 - 20864 Agrate Brianza (MB)

TEAM SHOFU ITALIA

Alessandro Pascucci
Managing Director Italy

Cell. 344 1024899 - pascucci@shofu.it

Giovanni Giansoldati

Key Account Manager- Product Specialist Italy

Cell. 328 8829022 - giansoldati@shofu.it

Gianluca Arnone

Digital Manager
Cell. 348 8951324
arnone@shofu.it

Corrado Garro

Area Manager North West
Cell. 340 2577184
garro@shofu.it

Alberto Astori

Sales Reps. Lombardia
Cell. 349 2262679
astori@shofu.it

Lorenzo Lo Gioco

Area Manager North East
Cell. 342 8621550
logioco@shofu.it

Luca Maremonti

Area Manager Central Italy
Cell. 345 6326346
maremonti@shofu.it

Fabio Tranchida

Sales Reps. South Italy
Cell. 342 6717061
tranchida@shofu.it



Friends of Shofu
Italy Group



ShofuDental
Italia

artegral[®] Life



Tessitura superficiale naturale
per effetti foto-ottici

Sfumature cromatiche armoniose dall'area
cervicale al bordo incisale



Trasparenza
incisale

Creste marginali
traslucenti

Bordo incisale
accentuato e
mammelloni
delicati

Le creste marginali dei
canini sono traslucidi
nella parte mesiale e più
scure in quella distale

Stratificazione buccale
dello smalto

Effetto di
profondità 3D

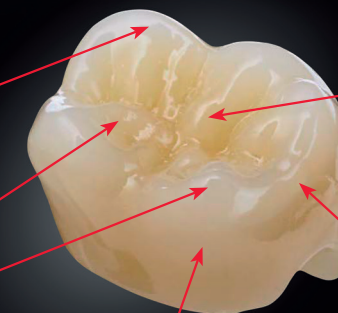

Smalto di rinforzo
per il molaggio
occlusale

Stratificazione linguale
e palatale dello smalto
(lungo tutta la circonferenza)

Creste marginali
consmalto di
rinforzo per il
molaggio

Official Partner



Minimally Invasive
Cosmetic Dentistry



SHOFU INC. 11 Kamitakamatsu-cho, Fukuine, Higashiyama-ku, Kyoto 605-0983, Japan
EC REP SHOFU DENTAL GmbH An der Pönt 70, 40885 Ratingen, Germany, www.shofu.de

SHOFU is a registered trademark of SHOFU INC. All other trademarks and registered trademarks are the property of their respective holders. SHOFU INC. reserves the right to change specifications without notice.